

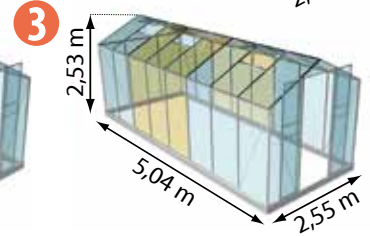

LAMS

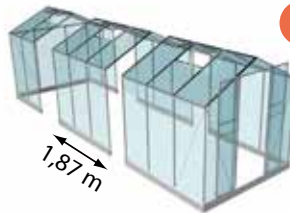
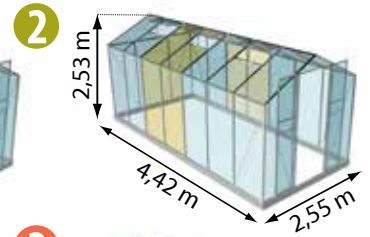
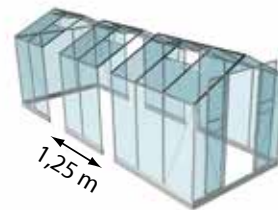
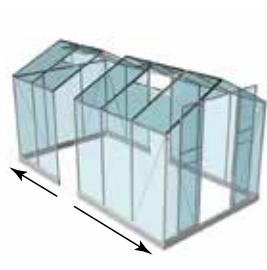
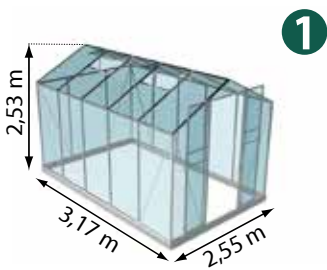
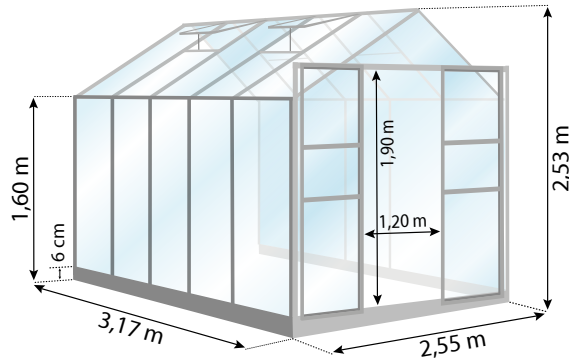

1 Module de base - Basismodul - Basic module
3,17 x 2,55 x 2,53 m (8,10 m²)

2 Extension - Erweiterung - Extension
1,25 x 2,55 x 2,53 m (3,20 m²)

3 Extension - Erweiterung - Extension
1,87 x 2,55 x 2,53 m (4,80 m²)

SERRES - GEWÄCHSHÄUSER - GREENHOUSES

LAURUS

~~8,10 M²~~ / 11,30 M² / ~~12,90 M²~~

MONTAGE BASE - MONTAGE FUNDAMENTTRAHMEN - BASE ASSEMBLING

Il est impératif que la base soit montée de niveau.



Es ist zwingend erforderlich, dass der Fundamentrahmen auf einem ebenen Untergrund montiert wird.

It is imperative that the greenhouse base is leveled.

Module de base
Basismodul
Basic module

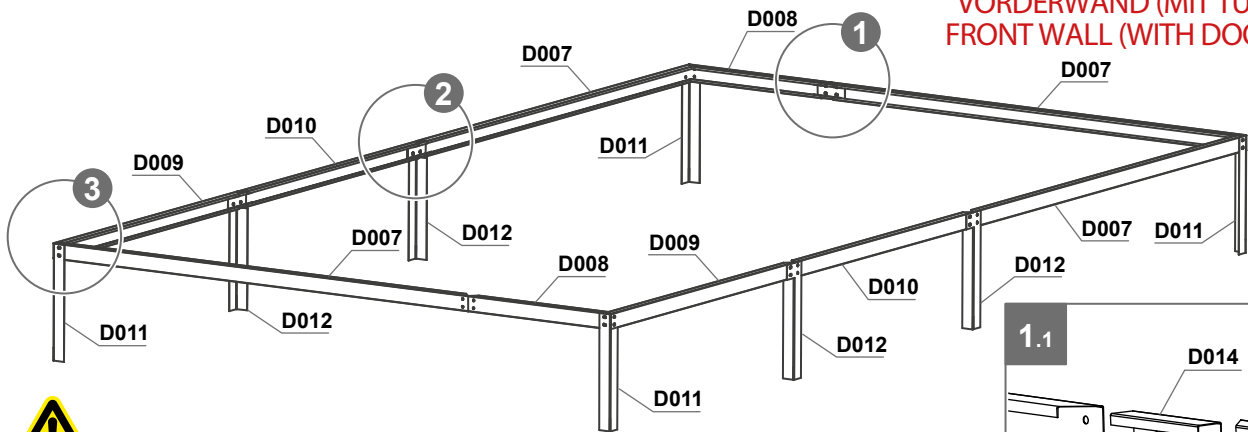
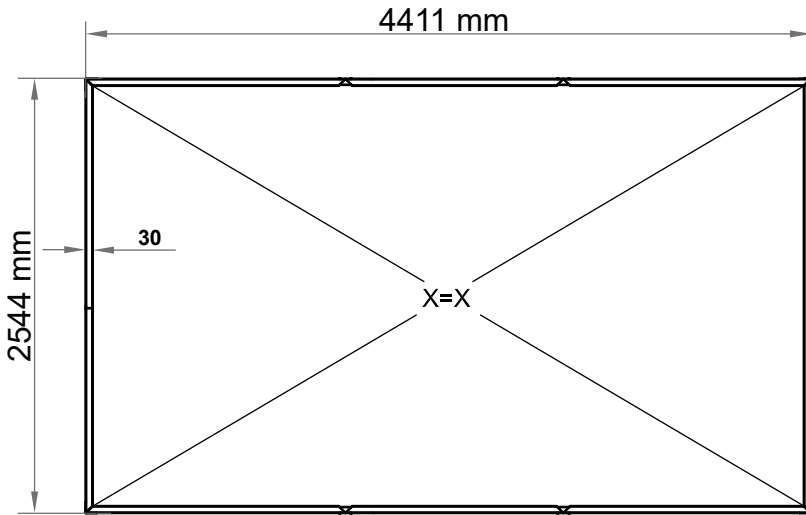

FACE AVANT (AVEC PORTE)
VORDERWAND (MIT TÜR)
FRONT WALL (WITH DOOR)



Plots béton / Punktfundament / Point foundation : D013 + D011 + D012.

Dalle ou pourtour béton / Streifenfundament / Concrete slab or frame : D013.

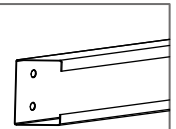
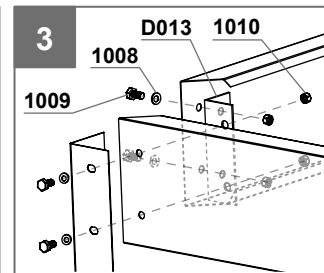
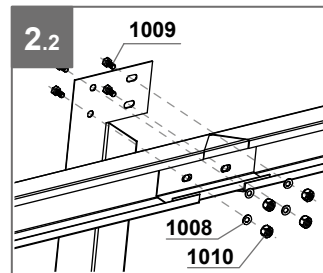
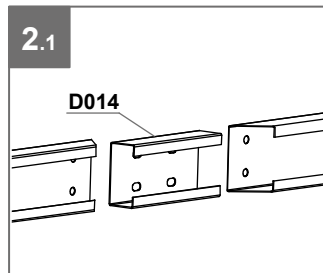
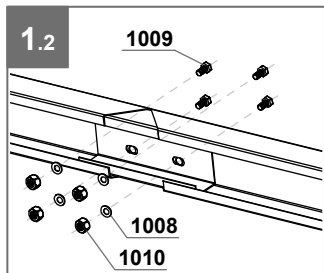

D007 x 4

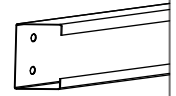

D008 x 2

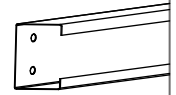

D009 x 2

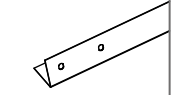

D011 x 4

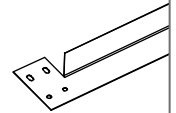

D012 x 2

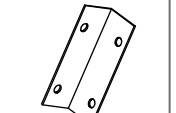

D013 x 4

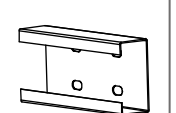

D014 x 4

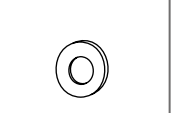

1008 x 32

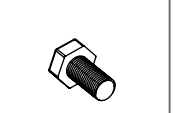

1009 x 32

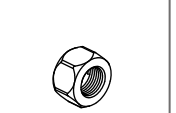

1010 x 32

Module d'extension
Erweiterungsmodul
Extension module

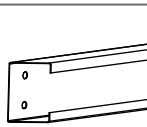

D010 x 2

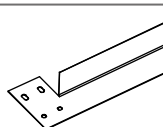

D012 x 2

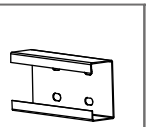

D014 x 2

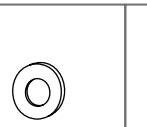

1008 x 8

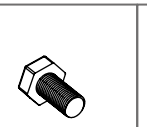

1009 x 8

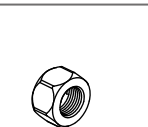

1010 x 8

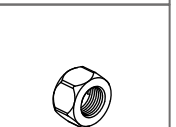

1010 x 32



FIXING THE GREENHOUSE BASE TO THE GROUND

FIXING ON SOIL (POINT FOUNDATION)

- Position the greenhouse base in the desired location at a level position.
- Locate the base legs as shown bellow.
- Mark a 300 x 300 mm square around the base legs and dig 450 mm deep.
- Place the greenhouse base, level it and fill the holes with concrete.

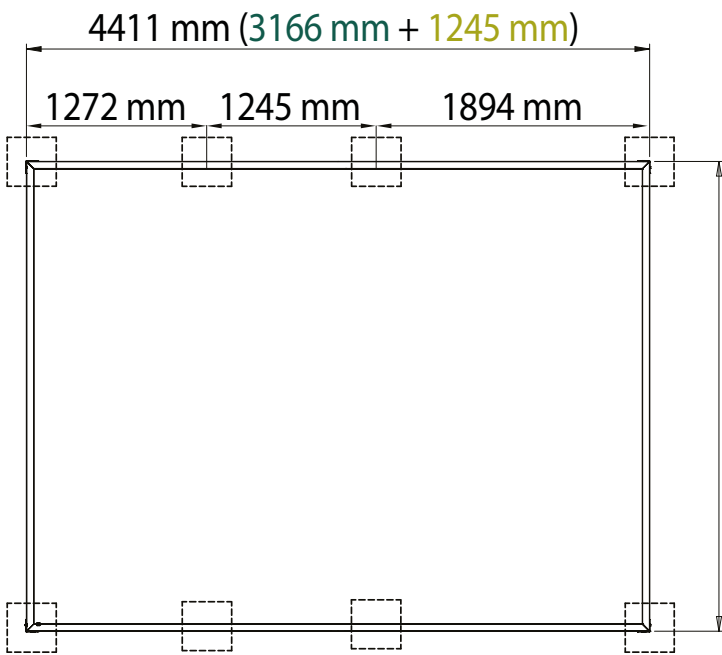

FRONT WALL (WITH DOOR)

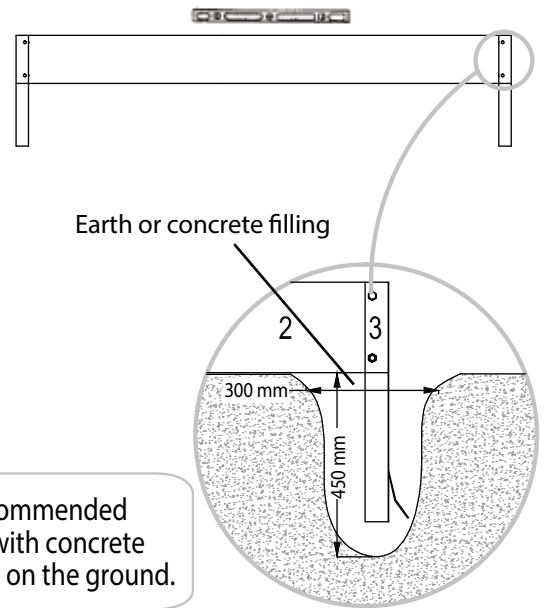

It is strongly recommended to fill the holes with concrete for a better hold on the ground.

OR

FIXING ON CONCRETE SLAB

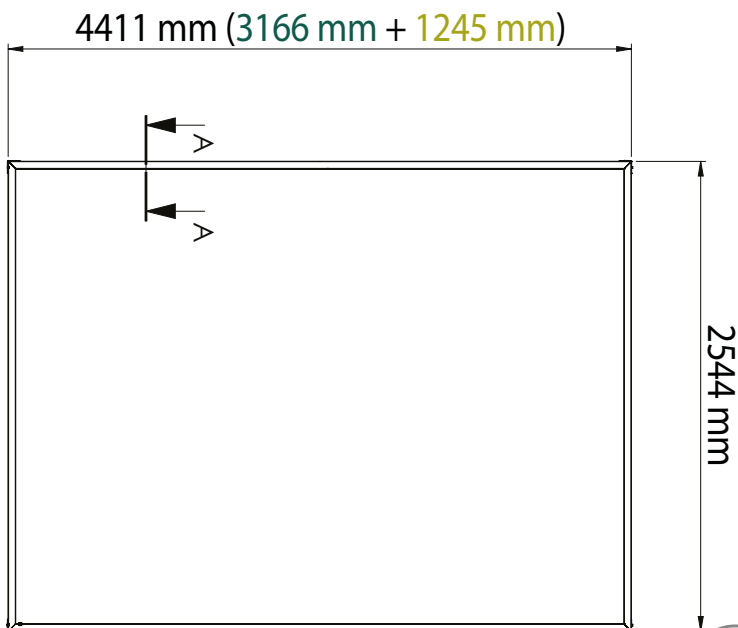

Detail A-A

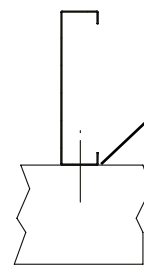

Rawplug fastening inside the greenhouse base



Screws and rawplugs not provided

It remains to your free choice and decision to use the suitable fastening means according to the supports you chose (wood border, building stones, cement plates etc.)